



Portable Vibrating
Mesh Nebulizer
User Guide

Model pe1200m

✓™ Fill



✓™ Click





✓™ Breathe

**USER: READ THIS GUIDE BEFORE OPERATING THIS DEVICE.
SAVE THIS GUIDE FOR FUTURE REFERENCE.**

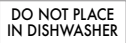
SYMBOLS

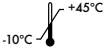
The symbols that appear on the box and the FLYP™ nebulizer are described below:

SYMBOL	MEANING
	Caution
	Consult instructions for use
	Keep dry
	Do not place in dishwasher

	Transient storage temperature limits -10°C to 45°C (14°F to 113°F)
	Federal law (USA) restricts this device to sale by or on the order of a physician or licensed practitioner.
	Type BF applied part
	Protected against insertion of fingers and will not become damaged or unsafe during a test in which it is exposed to vertically dripping water when held at an angle.

This page left blank intentionally.



Important information
to prevent damage to your
FLYP™ nebulizer

Important safety information
regarding hazards that may cause
personal injury

Before using your FLYP nebulizer for the first time, please read this User Guide and clean the parts. Be aware of all warnings and safety information. Only use accessories approved by Convexity and referenced within this manual. If you do not fully understand all the warnings, safety precautions, and operating instructions, contact Convexity for technical support. ALWAYS KEEP THIS USER GUIDE HANDY.

TABLE OF CONTENTS

Section 1: Introduction	
Intended Use	8-9
Section 2: Safety Guidelines	
Safety Guidelines.....	10-15
Section 3: Product Description	
Features and Benefits.....	16-17
Section 4: FLYP™ at a Glance	
Names and Functions of Parts.....	18-20
Section 5: Using FLYP	
About FLYP's Battery.....	21-23
Filling Medication Reservoir with Prescription.....	24-26
Turning FLYP ON and OFF.....	26-27
Inhaling Prescribed Medication.....	28

Section 6: Cleaning and Disinfecting	
Cleaning Parts	29-32
Disinfecting Parts.....	33-35
Section 7: Troubleshooting	
Troubleshooting	36-37
Section 8: Support	
Learning More	38
Section 9: Information	
Technical Data.....	39
Specifications.....	39-40
Aerosol Performance	41-42
Electromagnetic Compatibility	43-52
Disposal and Recycling	53
Warranty.....	53
Section 10: Replacement Parts and Accessories	54



Section 1: INTRODUCTION

INTENDED USE

Indications for use:

The FLYP™ nebulizer, for use by adolescent and adult patients, is intended to aerosolize healthcare provider-prescribed solutions for inhalation that are approved for use with a general-purpose nebulizer. FLYP is intended for use at home or a medical facility, such as a hospital or doctor's office.

Intended user:

FLYP nebulizer, for use by adolescent and adult patients, should only be used by a patient under the supervision of a qualified medical expert, such as a doctor, nurse, or respiratory therapist. The user, or their actively assisting caregiver, should be capable of understanding all of the User Guide's contents. FLYP is intended for use by a single user. FLYP is not a life-saving device. Patients who are in severe respiratory distress, who are unconscious, or who

are not breathing spontaneously should not use this device.

In an emergency, call 911 immediately for medical assistance.

Caution:

Federal law (USA) restricts this device to sale by or on the order of a physician or licensed practitioner.

Precautions:

All warnings and cautions described in the User Guide should be observed.

Service life:

FLYP has an expected service life of 36 months.

Section 2: SAFETY GUIDELINES

SAFETY GUIDELINES

Read this section to learn how to use FLYP™ safely and correctly and to prevent risks and injuries to you and others.

Keep this User Guide handy for future reference.

WARNING

Failure to follow these instructions could result in serious injury or damage to the device or other property. Read all the safety

information below before using the device.

Medical device:

FLYP is a medical device, available only by prescription and for prescribed medications.

Be sure to follow a qualified medical expert's instructions.

Direct exhaled medication away from others.

If you are using FLYP to treat a serious condition, a back-up device is recommended.

However, in a life-threatening situation, **NEVER** rely on a nebulizer. Call 911 immediately for emergency medical assistance.

Use by others:

For single patient use only.

If others use it, infection may spread.

Medical use:

FLYP is intended solely to deliver prescribed medication to treat a respiratory condition. Using FLYP for any other purpose is dangerous, and neither the distributor, manufacturer, nor

their affiliates can be held liable for any damage or injury caused by improper use or misuse.

Supervision required:

Adult supervision is required when the device is used by children and the infirm. If someone swallows small pieces, such as the Stopper, consult a doctor immediately. You should also be aware that the USB Wall Charger presents a potential choking hazard.

Cleaning:

Be sure to clean the Mouthpiece, Medication Reservoir and Stopper before using them for the first

time and after each subsequent use (refer to pages 29-32).

The Main Unit should be cleaned every day, but it should **NEVER** be placed in water or washed in a dishwashing machine. **ALWAYS** disconnect and unplug the USB Wall Charger before cleaning the Main Unit.

Do not drop medication on the Main Unit or into its USB port. If you drop medication on either area, immediately wipe it off with gauze. If you use FLYP™ while it is still wet, it may cause trouble or injury.

Battery:

The battery is not replaceable. Don't attempt to replace the battery yourself, as you may damage it. Overheating and injury could result. The lithium-ion battery should be replaced only by Convexity, and it must be recycled or disposed of separately from household waste. **NEVER** incinerate the battery. Incineration may cause the battery to rupture. If an ignition source exists, then fire and even an explosion could result. **NEVER** immerse the battery in water, as this may cause the battery to rupture.

Electronic device:

FLYP complies with all applicable electromagnetic compatibility (EMC) standards. You should, however, avoid operating it near other electronic devices.

If you are not going to use the unit for a long period of time, disconnect the USB Wall Charger.

Charging:

FLYP contains an internal, lithium-ion rechargeable battery that cannot be removed.

Charge FLYP only with the USB Wall Charger provided. **NEVER** use the device when it is charging.

Battery life should exceed 500 charge cycles. All batteries deteriorate over time if they are not used or charged. Do not store FLYP for long periods of time without charging it periodically. If FLYP is not used or charged for a long period of time, the battery may create a hazardous condition.

Proper handling:

FLYP contains sensitive components, including a stainless steel disk with carefully measured, 4-5 micron holes. Do not drop, crush, puncture, bend, heat, incinerate, or apply strong

shock to the device or its parts. If you are concerned about dirtying FLYP™, you can carry it in the Draw-String Bag.

- **NEVER** unscrew or open the Main Unit. Access the Medication Reservoir by opening the Reservoir Cover.
- Do not disassemble, repair, or modify FLYP. You may injure yourself or render the device ineffective.
- Keep the device away from heated surfaces and extreme heat and cold. Do not leave FLYP in a car if it will be subjected to significant heat or cold.

- Do not expose the device to direct sunlight. Keep the device away from children, pets, pests, lint and dust. You may render the device ineffective.
- FLYP is intended for use at home or a medical facility, such as a hospital or doctor's office.

Using cords and ports:

NEVER force the USB Wall Charger into the USB Port. Check for obstructions in the USB Port.

CAUTION

If the USB Wall Charger and USB Port don't join with reasonable ease, they probably don't match. Make sure that you are using the USB Wall Charger provided and that you have positioned it correctly.

Disposing of FLYP properly:

If, after proper cleaning and charging, FLYP takes longer than 10 minutes to deliver either 1 unit-dose of medication or 3 mL of normal saline (0.9%), the device should be replaced.

Consult "Troubleshooting" on pages 36-37 to see if corrective steps can be taken. For information about the proper disposal of FLYP, including other important regulatory compliance information, see "Disposal and Recycling" on page 53.

Intended environment:

The device is intended for indoor use.

Section 3: PRODUCT DESCRIPTION

FEATURES AND BENEFITS

Read this section to learn about FLYP's features and benefits.

Small and convenient:

FLYP™ fits in your pocket. There is no separate control unit, compressor, mask, hose or cup. And FLYP's convenient Draw-String Bag makes it easy to carry with you.

FLYP is rechargeable with a USB Wall Charger, like a cell phone. There are no disposable batteries. When fully charged, the battery can power an entire day's medical needs, which should not exceed 3 treatments.

Simple:

FLYP is designed for easy operation and delivers all medications approved for use with general-purpose nebulizers.

Silent:

FLYP operates almost silently, so it will not disturb children.

Fast and efficient:

FLYP delivers 1 unit-dose in approximately 7 minutes. It is designed to shut off automatically after 10 minutes to conserve battery life.

If after proper cleaning it takes longer than 10 minutes to deliver 3 mL of normal saline (0.9%), the device should be replaced.

Section 4: FLYP™ AT A GLANCE

NAMES AND FUNCTIONS OF PARTS

Read this section to learn the names and functions of the parts.

If any items are missing, contact the store where you purchased FLYP. You may also contact Convexity.

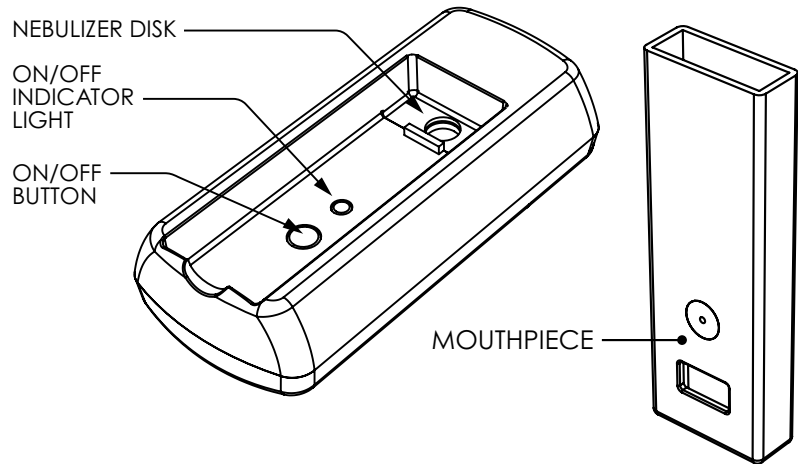
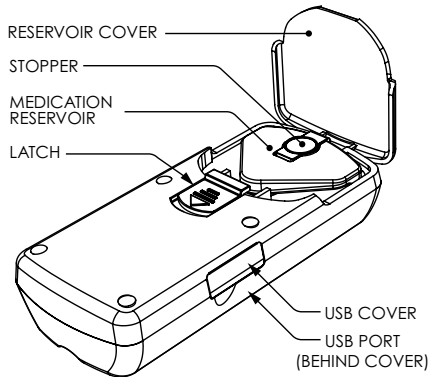

USB WALL CHARGER

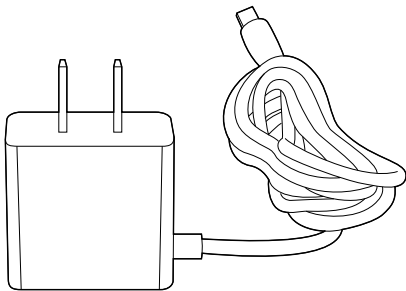

Note: the Draw-String Bag is not intended to protect FLYP™. It is provided for convenience only.

DRAW-STRING BAG

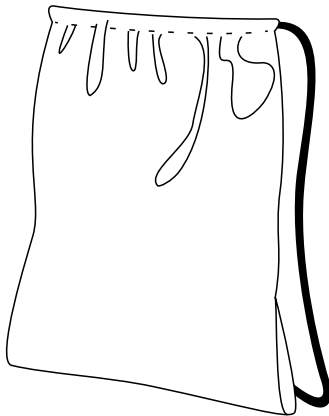

Section 5: USING FLYP™

ABOUT FLYP'S BATTERY

Read this section to learn how to use FLYP correctly.

About FLYP's battery:

FLYP is charged through a USB port, just as many cellular phones and portable electronic media devices are charged.

FLYP has an internal battery that you cannot replace. If your battery must be replaced,

contact Convexity Scientific at P.O. Box 297, Westport, CT 06880, (203) 557-6254.

For best results, use FLYP fully charged. Daily users should charge the device fully between uses. Do not allow the battery to remain unused or uncharged for a long period of time. It may create a hazardous condition.

Charging FLYP's battery:

You can charge FLYP's battery by connecting FLYP™ to a wall outlet using the USB Wall Charger provided. Only use the charger provided.

NEVER use the device while it is charging.

Connection via wall outlet

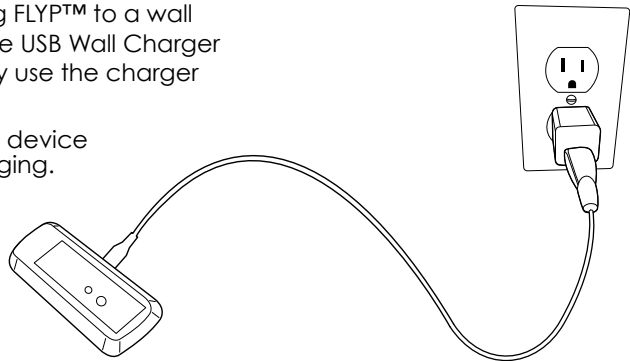

To charge the battery with a wall outlet:

1. Open the USB Cover to reveal the USB Port.
2. Gently insert the USB Wall Charger's Cord into the USB Port.
3. Insert the USB Wall Charger into a wall outlet.

Understanding battery states: When FLYP isn't connected to a power source, the On-Off Indicator Light has three possible states:

When FLYP is connected to a power source, the On-Off Indicator Light has two possible states:

Light Signal	Status
No Light	Go-Neb is Off
Blue Light	Go-Neb is On
Blue Light, Blinking	Battery is Low

Note: Rechargeable batteries don't have unlimited life. Battery life and number of charge cycles vary by use.

Light Signal	Status
Yellow Light, Blinking	Battery is Charging
Yellow Light, Solid	Battery is Fully Charged

FILLING MEDICATION RESERVOIR WITH PRESCRIPTION

There is no need to remove the Medication Reservoir to fill it with medication.

1. Open the Reservoir Cover, revealing the Medication Reservoir.

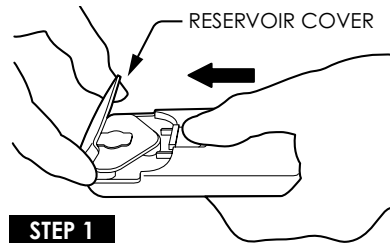

2. Unplug the Stopper from the Medication Reservoir.

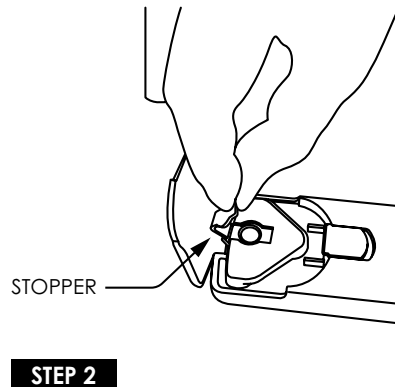

3. Carefully insert your medication ampule fully into the Medication Reservoir. Then squeeze the entire contents in, being careful not to spill any.

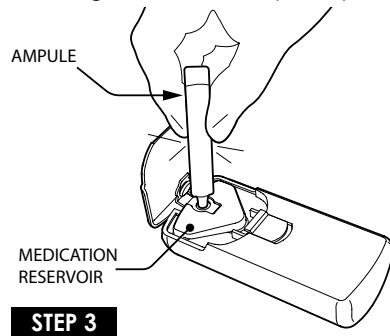

4. Once the medication is in the Medication Reservoir, reinsert the Stopper using your fingers. Be careful not to touch any part of the Stopper that may come in contact with your medication. Then close the Reservoir Cover.

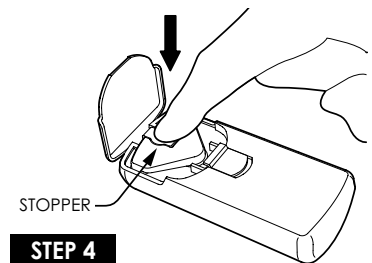

If you removed the Medication Reservoir in order to fill it with medication or to clean it, you will first need to reinsert the Medication Reservoir.

Note: the Medication Reservoir's maximum capacity is 5mL.

TURNING FLYP ON & OFF

Gently raise the Mouthpiece using your index finger, revealing the On-Off Button and On-Off Indicator Light.

To turn FLYP™ on, press the On-Off Button. The blue On-Off Indicator Light will light. Visually confirm that an aerosol mist is flowing from the Mouthpiece's end.

To turn FLYP off, press the On-Off Button again. The blue On-Off Indicator Light will no longer be lit.

FLYP will automatically turn off after 10 minutes.

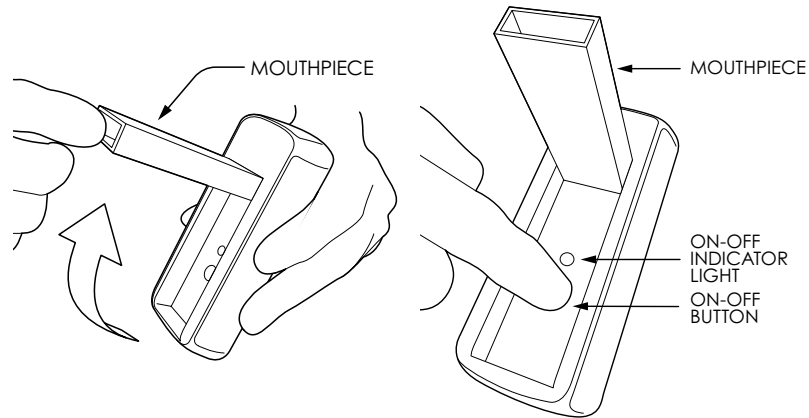

INHALING PRESCRIBED MEDICATION

Place the Mouthpiece between your lips. Inhale and breathe in a calm manner at a normal rate.

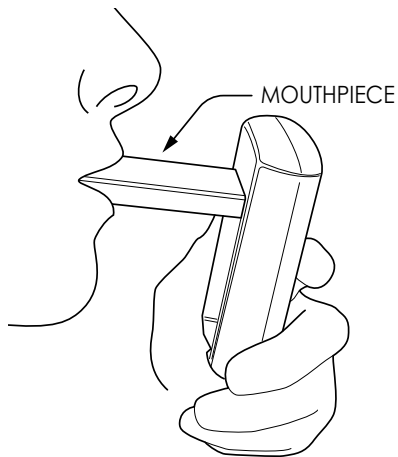

Section 6: CLEANING & DISINFECTING

CLEANING PARTS

Read this section to learn how to clean FLYP™, both before its first use and after each subsequent use.

ALWAYS disconnect and unplug the USB Wall Charger before cleaning or disinfecting

Cleaning the Mouthpiece and Medication Reservoir:

Remove the Mouthpiece by tugging on it gently. To remove the Medication Reservoir:

1. Lift the Reservoir Cover.

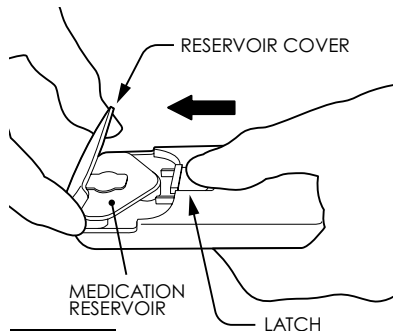

STEP 1

2. Pull gently on the Medication Reservoir.

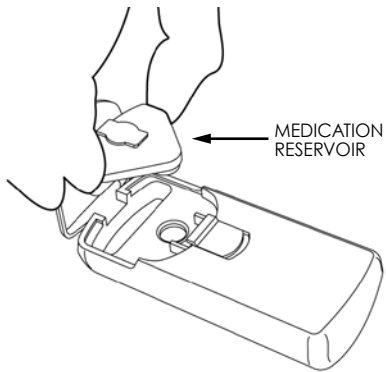

3. Unplug the Stopper from the Medication Reservoir.

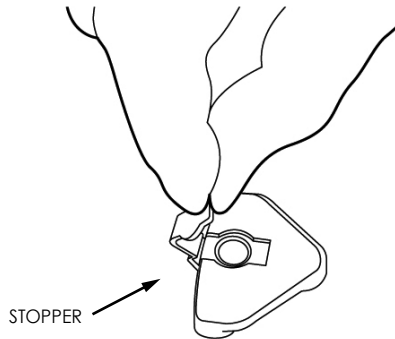

Prepare a solution of warm water and mild liquid dishwashing soap. Wash the Mouthpiece and Medication Reservoir in the soap solution. Rinse the Mouthpiece and Medication Reservoir under running tap water. These are the only parts that can be cleaned with water. Shake off excess water and dry on clean, dry towel. **NEVER rinse the Main Unit under running water.**

Cleaning the Main Unit's exterior: Prior to cleaning the Main Unit's exterior, disconnect and unplug the USB Wall Charger, make sure the USB Cover is closed tightly,

and remove the Mouthpiece. Prepare a solution of warm water and mild dishwashing soap. Then clean the Main Unit by wiping it with gauze lightly moistened by the soap solution. Use a clean gauze moistened with warm tap water to remove any soap residue. To dry the Main Unit, wipe it with dry gauze. Make sure it is completely dry before reinserting the Mouthpiece and storing it.

NEVER place the Main Unit or USB Wall Charger in water or hold them under running water. The lithium-ion battery inside the Main Unit may be dangerous when wet.

NEVER use window cleaners, aerosol sprays, solvents, ammonia, or abrasives to clean FLYP™.

Cleaning the Main Unit's interior:

1. Fill the Medication Reservoir with distilled water.
2. Plug the Stopper to seal the Medication Reservoir.
3. Close the Reservoir Cover.
4. Gently raise the Mouthpiece with your index finger.
5. Turn FLYP on and allow the aerosol mist to flow from the raised Mouthpiece for 1 minute.
6. Unplug the Stopper and Remove the Medication Reservoir.

7. Shake excess distilled water from the Medication Reservoir.
8. Let the Medication Reservoir dry on a clean, dry towel.
9. Let the Main Unit dry on a clean, dry towel with the Reservoir Cover open. Allow the Main Unit's interior to dry fully before using it again.

It is important to clean the Main Unit's interior to prevent medication from drying there. If these steps are not followed, the 4-5 micron holes on the Nebulizer Disk may become clogged, and it may not perform properly.

DISINFECTING PARTS

Read this section to learn how to disinfect FLYP. Although disinfection is optional, it is recommended that you do it at the end of every day.

Disinfecting the Mouthpiece and Medication Reservoir:

1. Remove the Mouthpiece and Medication Reservoir.
2. Soak the Mouthpiece and Medication Reservoir in 70% ethyl alcohol for 10 minutes. Make sure they are completely covered with ethyl alcohol.

3. Shake off the excess ethyl alcohol and rinse the Mouthpiece and Medication Reservoir under running tap water.
4. Let the Mouthpiece and Medication Reservoir dry on a clean, dry towel.

Disinfecting the Main Unit's interior:

1. Place FLYP on a flat surface and remove the Mouthpiece.
2. Place a few drops of ethyl alcohol on the Nebulizer Disk. Use just enough to cover the Disk completely. Be careful not to spill any. Using a dropper may help.

3. Let the ethyl alcohol sit for 10 minutes. Then shake off the ethyl alcohol from the Nebulizer Disk.
4. Turn FLYP over. Open the Reservoir Cover and remove the Medication Reservoir.
5. Repeat steps 2 and 3 on this side of the Nebulizer Disk.
6. Place a few drops of distilled water on the Nebulizer Disk. Then shake off the distilled water. Repeat on the other side of the Nebulizer Disk.

Then remove the ethyl alcohol from the interior:

1. Reinsert the Medication Reservoir and Mouthpiece.

2. Fill the Medication Reservoir with distilled water.
3. Plug the Stopper.
4. Close the Reservoir Cover.
5. Gently raise the Mouthpiece with your index finger.
6. Turn FLYP™ on and allow the mist to flow from the raised Mouthpiece for 10 minutes.
7. Unplug the Stopper and remove the Medication Reservoir.
8. Shake excess distilled water from the Medication Reservoir.
9. Let the Medication Reservoir dry on a clean, dry towel.

10. Let the Main Unit dry on a clean, dry towel.
11. Allow the Main Unit to dry fully before using it again.

Disinfecting the Main Unit's exterior:

Before disinfecting the Main Unit's exterior, make sure the USB Cover is closed tightly. Disinfect the Main Unit's exterior by wiping it with a clean, dry towel lightly moistened with ethyl alcohol. Then allow the Main Unit to sit for 5 minutes. Moisten a clean, dry towel with water and wipe the Main Unit to remove the ethyl alcohol. Allow to air dry.

NEVER immerse the Main Unit or USB Wall Charger in ethyl alcohol. The lithium-ion battery inside the Main Unit may be dangerous when wet.

NEVER use window cleaners, aerosol sprays, solvents, ammonia, or abrasives to disinfect FLYP.

Section 7: TROUBLESHOOTING

TROUBLESHOOTING

Most problems with the device can be solved by following this advice.

The following table describes possible troubles, their causes, and what corrective action to take.

If these corrective actions do not return FLYP™ to full working order, read the next section, "Support."

TROUBLE	POSSIBLE CAUSE	CORRECTIVE ACTION
The nebulization rate is extremely low.	The battery is low.	Charge FLYP using a USB port. Refer to pages 22-23.
	An air bubble has formed in the medication's pathway.	Tap the back of the Main Unit with your index finger until normal flow resumes.
	The Nebulizer Disk has become clogged with medication.	Nebulize distilled water for 1 minute. Refer to pages 29-32.
The On-Off Indicator Light is on, but there is no mist.	The Medication Reservoir is not correctly inserted.	Remove the Medication Reservoir and install it correctly.
	The Medication Reservoir is not filled.	Fill with medication. Refer to pages 24-26.
	Check that FLYP has been properly cleaned.	Nebulize distilled water for 1 minute. Refer to pages 29-32.

Section 8: SUPPORT

You can find more information about using FLYP™ on our website. To learn about service and support, and to view tutorials, go to: www.ConvexityScientific.com/support/FLYP

NOTES:

Section 9: INFORMATION

TECHNICAL DATA

Technical Specifications:

Length: 119 mm

Width: 54 mm

Depth: 27 mm

Weight: 102 g
(with battery)

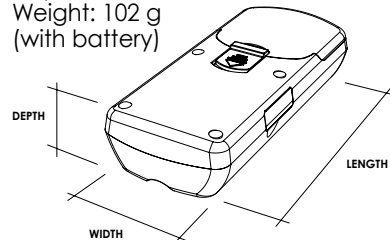

SPECIFICATIONS

Indications for use:

The FLYP™ nebulizer, for use by adolescent and adult patients, is intended to aerosolize healthcare provider-prescribed solutions for inhalation that are approved for use with a general-purpose nebulizer. FLYP is intended for use at home or a medical facility, such as a hospital or doctor's office.

Power supply:

Shenzhen Simsukian Electronics
Technology,
model SK12G-0050100U
Rated 100-240V, 50/60Hz, 0.2A

Patient population:

Adolescent to adult

Method of operation:

Piezoelectric/Ultrasonic

Power source:

Lithium-ion battery (rechargeable)

Weight:

FLYP: 102 g (with battery)

Dimensions:

27 x 119 x 54 mm (Main Unit)

Sound level:

<35 dBA at 1 meter

Operating conditions:

Temperature range: 5°C to +40°C
(+41°F to +104°F)

Humidity: up to 95% RH

Storage conditions:

Temperature range: -10°C to
+45°C (14°F to +113°F)

Humidity: up to 93% RH

Aerosol Performance

	Albuterol sulfate	Ipratropium bromide	Cromolyn sodium
MMAD (μ)	2.31 +/- 0.10	2.17 +/- 0.05	2.26 +/- 0.11
GSD (geometric standard deviation)	1.60 +/- 0.07	1.48 +/- 0.03	1.54 +/- 0.06
Total delivered dose (μ)	1038.8 +/- 127.3	230.8 +/- 19.3	958.4 +/- 129.0
Total respirable dose (μ)	921.6 +/- 70.3	209.4 +/- 14.9	857.7 +/- 84.4
Respirable fraction (% mass 0.4-4.7 μ)	87.8%	90.3%	88.1%

All data shown at a 95% confidence level. Medications were tested 3 times each on 3 devices for a total of 27 sample data points.

Aerosol Performance			
	Albuterol sulfate	Ipratropium bromide	Cromolyn sodium
Coarse particle dose (μ)	69.2 +/- 36.1	7.4 +/- 3.8	85.7 +/- 37.2
Fine particle dose (μ)	969.7 +/- 74.2	223.4 +/- 16.3	872.7 +/- 80.9
Extra fine particle dose (μ)	374.9 +/- 42.0	89.8 +/- 6.7	356.7 +/- 47.4
Coarse fraction ($>4.7\mu$)	6.7%	3.1%	8.9%
Fine fraction ($<4.7\mu$)	92.4%	96.3%	89.7%
Extra fine fraction ($<1.0\mu$)	35.7%	38.7%	36.6%

All data shown at a 95% confidence level. Medications were tested 3 times each on 3 devices for a total of 27 sample data points.

ELECTROMAGNETIC COMPATIBILITY

With the increased number of electronic devices, such as computers and cellular phones, medical devices in use may be susceptible to electromagnetic interference. This interference may result in incorrect operation of the medical device and create a potentially unsafe situation. Do not use cellular phones and other electronic devices that generate electromagnetic fields near the medical device.

Medical Electrical Equipment needs special precautions regarding EMC and needs to be installed and put into service according to the EMC information provided in this User Guide.

Portable and Mobile RF Communications Equipment can affect Medical Electrical Equipment.

The use of accessories, transducers and/or cables other than those specified, with the exception of those sold by the manufacturer as replacement

parts for internal components, may result in increased emissions or decreased immunity of the equipment or system.

The equipment or system should not be used adjacent to or stacked with other equipment and that if adjacent or stacked use is necessary, the equipment or system should be observed to verify normal operation in the configuration in which it will be used.

EMC Tables. The following tables are provided in accordance with IEC 60601-1-2: 2014, ed. 4.0.

Guidance and Manufacturer's Declaration - Emissions

The FLYP™ pe1200m is intended for use in the electromagnetic environment specified below. The customer or user of the FLYP pe1200m should ensure that it is used in such an environment.
--

Emissions Test	Compliance	Electromagnetic Environment – Guidance
Radiated Emissions: CISPR 11	Class B	
Conducted Emissions: CISPR 11	Class B	

EMC Tables. The following tables are provided in accordance with IEC 60601-1-2: 2014, ed. 4.0.

Guidance and Manufacturer's Declaration - Emissions		
The FLYP™ pe1200m is intended for use in the electromagnetic environment specified below. The customer or user of the FLYP pe1200m should ensure that it is used in such an environment.		
Emissions Test	Compliance	Electromagnetic Environment – Guidance
Harmonics: IEC61000-3-2	Not Applicable	
Flicker: IEC61000-3-3	Not Applicable	The FLYP pe1200m is suitable for use in all establishments, including domestic, and those directly connected the public low-voltage power supply network that supplies buildings used for domestic purposes.

Guidance and Manufacturer's Declaration – Immunity			
The FLYP pe1200m is intended for use in the electromagnetic environment specified below. The customer or user of the FLYP pe1200m should ensure that it is used in such an environment.			
Immunity Test	IEC 60601 Test Level	Compliance Level	Electromagnetic Environment – Guidance
ESD: IEC61000-4-2	±8kV Contact ±2kV, ±4kV, ±8kV, ±15kV Air	±8kV Contact ±2kV, ±4kV, ±8kV, ±15kV Air	Floors should be wood, concrete, or ceramic tile. If floors are covered with synthetic material, the relative humidity should be 30%.
EFT: IEC61000-4-4	+/- 0.5 KV L1 and L2 +/- 1 KV L1 and L2	+/- 0.5 KV L1 and L2 +/- 1 KV L1 and L2	Mains power quality should be that of a typical commercial or hospital environment.
Surges: IEC61000-4-5	+/- 0.5 KV L1 and L2 +/- 1 KV L1 and L2	+/- 0.5 KV L1 and L2 +/- 1 KV L1 and L2	Mains power quality should be that of a typical commercial or hospital environment.

Guidance and Manufacturer's Declaration – Immunity

The FLYP™ pe1200m is intended for use in the electromagnetic environment specified below. The customer or user of the FLYP pe1200m should ensure that it is used in such an environment.

Immunity Test	IEC 60601 Test Level	Compliance Level	Electromagnetic Environment – Guidance
Voltage dips and interruptions: IEC61000-4-11	<p>0 % UT: 0.5 cycle at 0°, 45°, 90°, 135°, 180°, 225°, 270° and 315°.</p> <p>0% UT: 1 cycle</p> <p>70% UT: 25 cycles for 50 Hz</p> <p>Single phase: at 0°</p> <p>0 % UT; 250/300 cycle for 50 Hz and 60 Hz</p>	<p>0 % UT: 0.5 cycle at 0°, 45°, 90°, 135°, 180°, 225°, 270° and 315°.</p> <p>0% UT: 1 cycle</p> <p>70% UT: 25 cycles for 50 Hz</p> <p>Single phase: at 0°</p> <p>0 % UT; 250/300 cycle for 50 Hz and 60 Hz</p>	<p>Mains power quality should be that of a typical commercial or hospital environment. If the user of the FLYP pe1200m requires continued charging during mains power interruptions, it is recommended that the FLYP pe1200m be powered from an uninterruptible power supply or battery.</p>

Immunity Test	IEC 60601 Test Level	Compliance Level	Electromagnetic Environment Guidance
Power Frequency 50/60Hz Magnetic Field: IEC61000-4-8	30 A/m	30 A/m	Power frequency magnetic fields should be at levels characteristic of a typical location in a typical commercial or hospital environment.

Guidance and Manufacturer's Declaration – Immunity

The FLYP™ pe1200m is intended for use in the electromagnetic environment specified below. The customer or user of the FLYP pe1200m should ensure that it is used in such an environment.

Immunity Test	IEC 60601 Test Level	Compliance Level
Conducted RF: IEC61000-4-4	3 Vrms 0.15-80 MHz 6 Vrms in ISM and Amateur radio bands	3 Vrms 0.15-80 MHz 6 Vrms in ISM and Amateur radio bands
Radiated RF: IEC61000-4-3	10 V/m 80 MHz - 2.7 GHz 1 kHz @ 80% AM	10 V/m 80 MHz - 2.7 GHz 1 kHz @ 80% AM

Electromagnetic Environment – Guidance

Portable and mobile communications equipment should be separated from the FLYP pe1200m by no less than the distances calculated/listed below:

$$D = (3.5/V1)(\text{Sqrt } P)$$

150kHz to 80 MHz

where P is the max. power in watts and D is the recommended separation distance in meters.

$$D = (3.5/E1)(\text{Sqrt } P)$$

80 to 800 MHz

Field strengths from fixed transmitters, as determined by an electromagnetic site survey, should be less than the compliance levels (V1 and E1).

$$D = (7/E1)(\text{Sqrt } P)$$

800 MHz to 2.5 GHz

Interference may occur in the vicinity of equipment containing a transmitter.

Recommended Separation Distances for the FLYP pel200m

The FLYP™ pel200m is intended for use in the electromagnetic environment in which radiated disturbances are controlled. The customer or user of the FLYP pel200m can help prevent electromagnetic interference by maintaining a minimum distance between portable and mobile RF Communications Equipment and the FLYP pel200m as recommended below, according to the maximum output power of the communications equipment.

Max Output Power (Watts)	Separation (m) 150kHz to 80MHz $D=(3.5/\sqrt{P})$	Separation (m) 80 to 800MHz $D=(3.5/\sqrt{P})$	Separation (m) 800MHz to 2.5GHz $D=(7/\sqrt{P})$
0.01	0.116667	0.116667	0.233333
0.1	0.368932	0.368932	0.737865
1	1.166667	1.166667	2.333333
10	3.689324	3.689324	7.378648
100	11.66667	11.66667	23.33333

DISPOSAL & RECYCLING

CAUTION

Your FLYP must be disposed of properly, according to local laws and regulations. Because this product contains a battery, the product must be disposed of separately from household waste. When your FLYP reaches its end of life, contact your local authorities to learn about recycling options.

WARRANTY

FLYP is warranted for a period of thirty-six months from the date of purchase against defects in manufacturing. All warranties are based on typical usage.

Section 10: REPLACEMENT PARTS AND ACCESSORIES

PART	REORDER NUMBER
Mouthpiece	AIR-1000
Medication Reservoir	AIR-2000
USB Wall Charger	AIR-3000
Draw-String Bag	AIR-4000
User Guide	AIR-5000

This page left blank intentionally.



CONVEXITY
SCIENTIFIC

CONVEXITY SCIENTIFIC INC.
P.O. Box 297
Westport, CT 06880
(203) 557-6254